

Характеристики:

- Широкий диапазон
- Высокая чувствительность
- Низкий КСВН

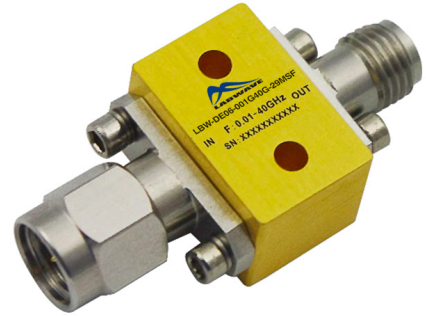

Parameters	Min.	Typ.	Max.	Units
Frequency Range	0.01		40	GHz
VSWR		1.5	2.0	: 1
Tss	-25			dBm
Sensitivity	0.1	0.3		mv/uw
Input Power			23	dBm
Output Polarity	Negative(-)			
Weight	0.4 Max.			ounces
Input / Output Connectors	2.92-Male / SMA-Female			
Material	Aluminum			
Finish	Gold Plated			

Широкополосный детектор мощности 0,01 - 40 ГГц

Environmental Specifications

Operational Temperature(°C)	-40°C~+85°C
Storage Temperature (°C)	-50°C~+105°C
Altitude	30,000 ft. (Epoxy Sealed Controlled environment)
	60,000 ft. 1.0psi min (Hermetically Sealed Un-controlled environment) (Optional)
Vibration	25g RMS (15 degrees 2KHz) endurance, 1 hour per axis
Humidity	100% RH at 35°C, 95%RH at 40°C
Shock	20G for 11msec half sine wave,3 axis both directions

Outline Drawing:

All Dimensions in mm (inches) Tolerance $\pm 0.1(0.004)$

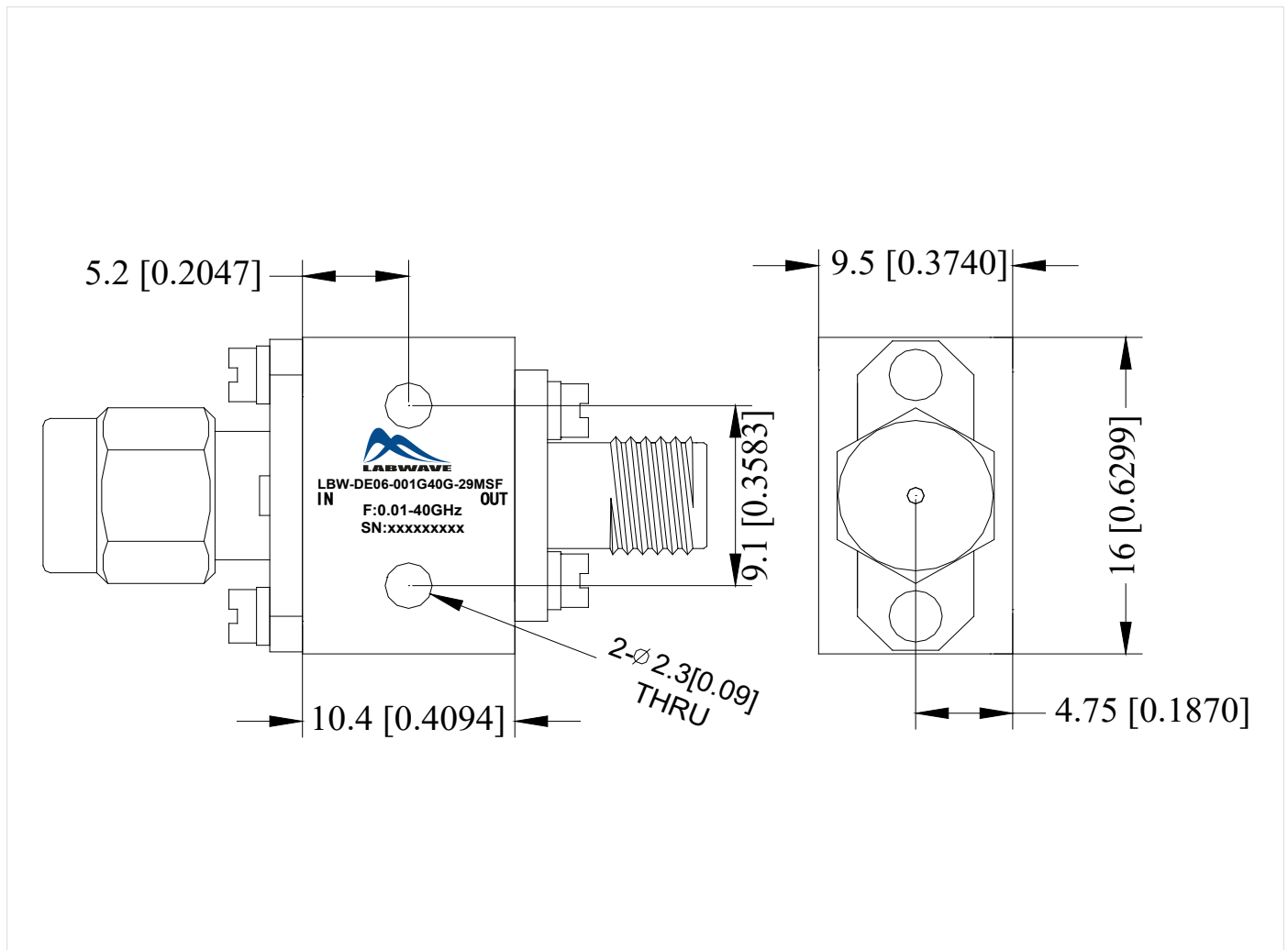

Широкополосный детектор мощности 0,01 - 40 ГГц

VSWR @+25°C

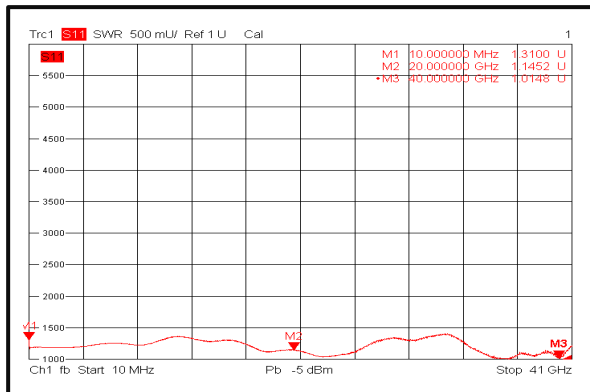

VSWR @-40°C

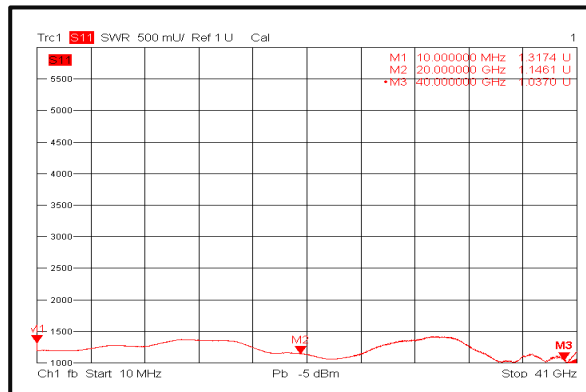

VSWR @+85°C

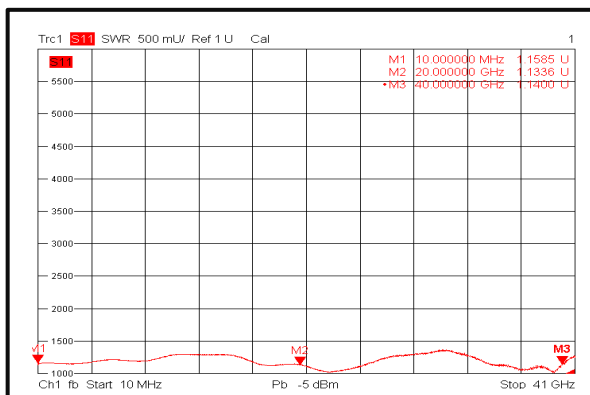

Output DC Voltage vs. Input Power

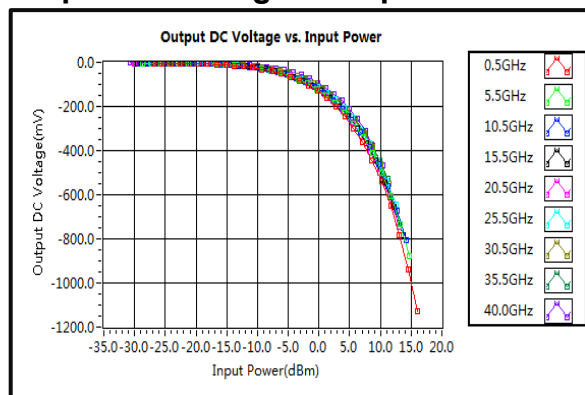

Rise Time

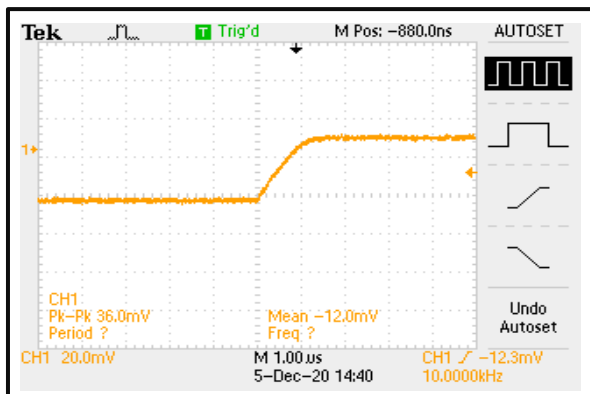

Fall Time

